

Ready to learn more?

<http://www.daitronpower.com>

For more information, visit our website at <http://www.daitronpower.com> or access from the QR code.

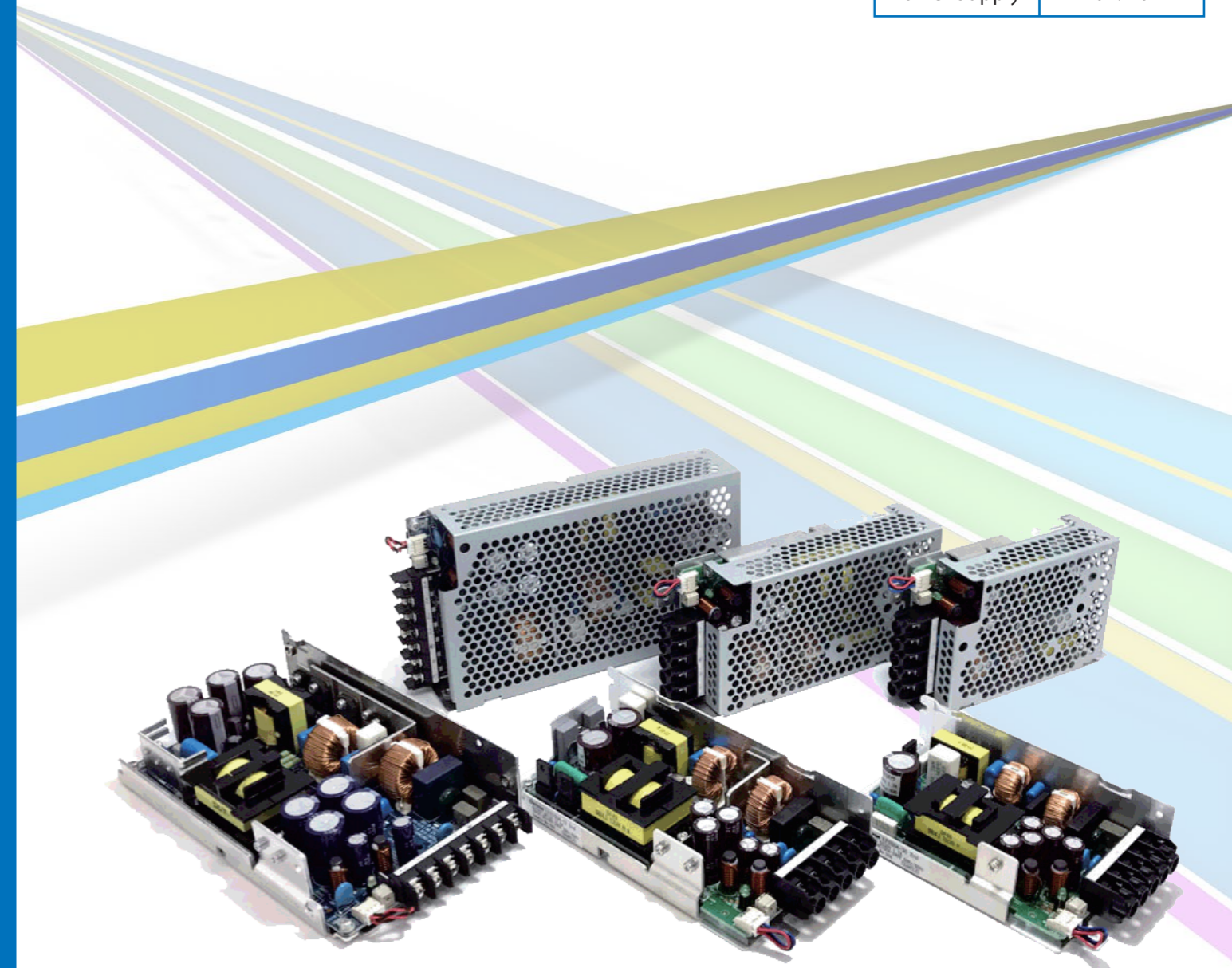
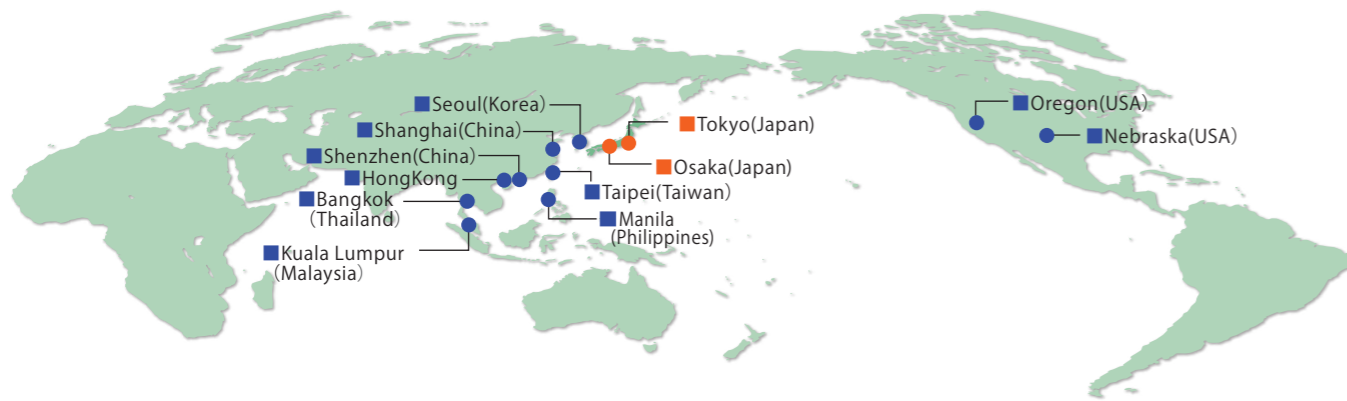

Daitron
DAITRON CO., LTD.

Product: <http://www.daitronpower.com>
Corporate: <http://www.daitronglobal.com> E-mail: ask-global@daitron.co.jp

Head Office	6-11, Miyahara 4-chome, Yodogawa-ku, Osaka 532-0003 Japan	Phone: _____
Sales Promotion Dept.	15-1, Fujimidai 3chome, Kunitachi, Tokyo 186-0003, Japan	Phone: +81-42-571-8433
Daitron Inc.	9720 SW Hillman Court Suite 805, Wilsonville OR 97070, U.S.A.	Phone: +1-503-682-7560
Daitron (Korea) Co., Ltd.	7th Floor, E&C Venture Dream Tower 6 Cha, Guro-dong, Guro-gu, Seoul, 152-719 Korea	Phone: +82-2-6910-3300
Daitron (Shanghai) Co., Ltd.	Fuxing Plaza, 4F 410, No.109 Yandang Road, Huangpu district, Shanghai, 200020 China	Phone: +86-21-6093-2193
Daitron (Shenzhen) Co., Ltd.	Room 1617, 16/F, Pacific Commercial&Trade Building, No.4028 Jiabin Road, Luohu District, Shenzhen, 518010 China	Phone: +86-755-2590-4712
Daitron (H.K) Co., Ltd.	Room 806-07, 9 Wing Hong Street, Cheung Sha Wan, Kowloon, Hong Kong	Phone: +852-2838-0682
Daitron Co.,Ltd. Taipei Branch	11F., No 19, Sec. 1, Hang Chou S. Rd., Taipei, 100-53 Taiwan	Phone: +886-2-2394-5134
Daitron Co.,Ltd. Manila Office	Unit 503, Alpap II Building, Trade St., Cor. Investment Drive, Madrigal Business Park, Ayala Alabang, Muntinlupa City, Metro Manila, Philippines	Phone: +63-2-550-2832
Daitron (Thailand) Co., Ltd.	75/105(Suite:A) 38th Fl., Ocean Tower 2, Soi Sukhumvit 19 (Wattana), Sukhumvit Road, Khlong Toey Nua, Wattana, Bangkok 10110, Thailand	Phone: +66-2-661-7265
Daitron (Malaysia) Sdn. Bhd.	Level 25 Unit 8, Menara Permata Damansara (Oval Tower) No. 685, Jalan Damansara 60000 Kuala Lumpur, Malaysia	Phone: +60-3-7732-2081

Daitron

Ultra Low Noise
Power Supply Product



Products Site

Get rid of Linear Power Supply

Switching power supply is a large noise source!

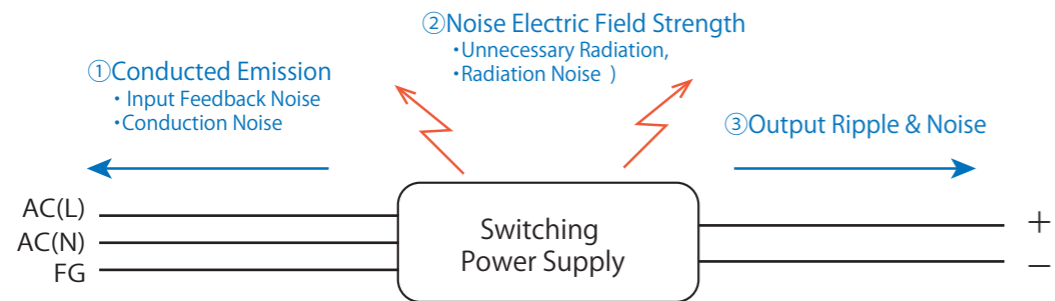

Features

Daitron's Power Supply provides the most quiet output power for customers' applications. Featuring built-in Soft-switching topology based technology that reduces the noise level for sensitive systems. The topology creates a clean current wave and our engineers carefully designed current and voltage timing synchronized at "Zero-Cross (ZVS¹, ZCS²)" point, achieving our goal of a power supply operating at the lowest possible noise level. This is how our ultra low noise power supply can meet our customer's requirement to achieve ultra low noise switching power in a small and light weight unit. This ultra low noise feature also brings the benefit for customer design engineers to save on design resources. Our ultra low noise power supply can reduce external output filters with very low leakage current.

Hard Switching

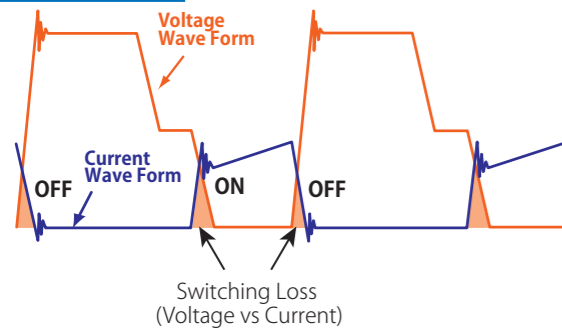

Soft Switching

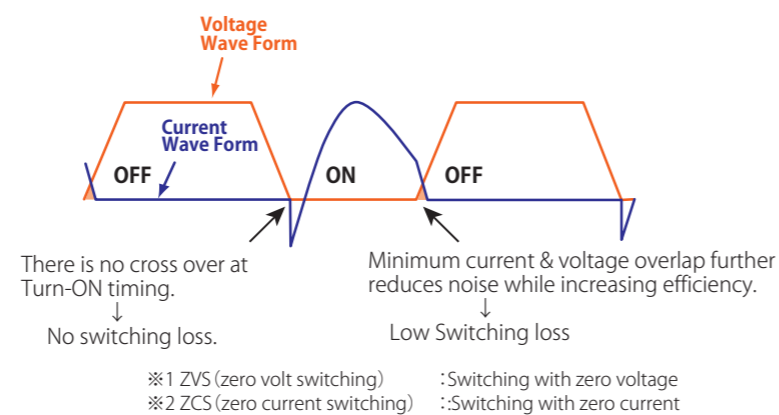

Comparison with Competitors

Compared with other Hard-Switching power supplies, we reduce noise level dramatically down to 1/10 value, as seen below. Additionally, Daitron's product has better noise electric field strength and we reduce conduction noise to Class B required levels, as seen below, meaning our customers save resources for noise immunity testing.

Output Ripple & Noise

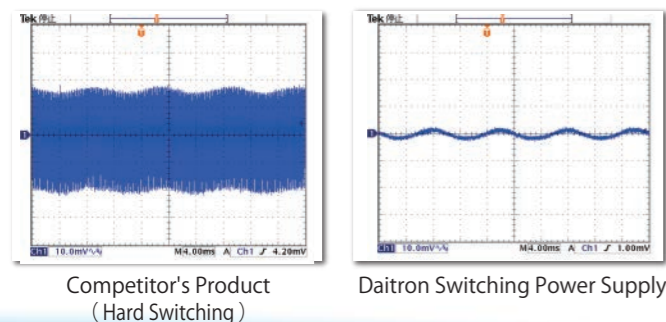

Conducted Emission

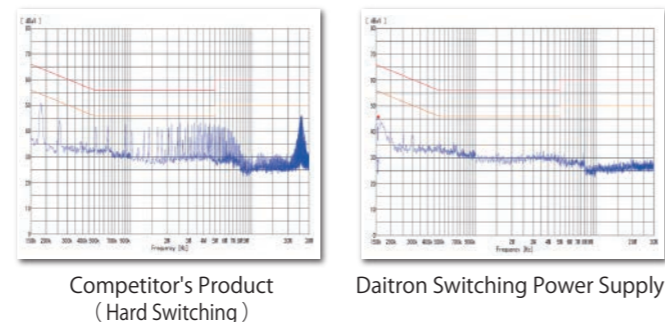

Why Daitron Power Supply

- **Improve S/N Ratio**
Since the noise and conducted emission from the power supply are extremely low, a minute signal can be accurately provided to devices.
- **Low Leakage Current**
Conforming to various safety standards.
- **Terminal block with screw fall prevention** (※LFS series)
Preventing screws from falling off during wiring.
- **Small, Light Weight and High Efficiency**
We achieve the small, lightweight & high efficiency features of a switching power supply while maintaining the low noise performance of a linear power supply.

	LINEAR POWER SUPPLY	HARD SWITCHING POWER SUPPLY	DAITRON SOFT SWITCHING POWER SUPPLY
Noise Level	○	×	○
Size	×	○	○
Leakage Current	○	×	○
Weight	×	○	○
Component Count	○	×	○
Efficiency	×	○	○

Use

High precision equipment and machines requiring low noise and low leakage current, such as measuring instruments, laboratory instruments, medical equipment, and production facilities

Application

- **Microscopy <SEM/TEM>**
Improve Magnification
- **Medical Imaging/Diagnosis**
Lower Leakage Current than Medical Requirement
Ultra low conduction noise & low emission noise feature makes power supply design smaller and lighter than ever
Save resources for medical approval in customer's design
- **Nanoscale measurement, Image sensing and image processing**
Optimize minimize noise interference from the power source.
- **Audio**
Reduce Audible noise and improved S/N Ratio will reproduce closer to the real sound.

Products Selection Guide

Product Series	LFS50A	LFS150A	PFS300A
Appearance			
Output (W)	50	150 (100W for 5V only)	300
Input Voltage (VAC)	85 ~ 264	85 ~ 264	85 ~ 264
Ripple & Noise (mV)	10	10 (13W for 48V only)	10
Output (V)	5/12/15/24/30/48	5/12/15/24/30/48	12/15/24/30/48
Safety Standards	60950-1 60601-1 Conforming to the Electrical Appliance and Material Safety Law		
CE	Low Voltage Directive		

※Values are subject to change.